

ISO 4014 / DIN 931, hexagon head bolt, M 6x95, 8.8, pln

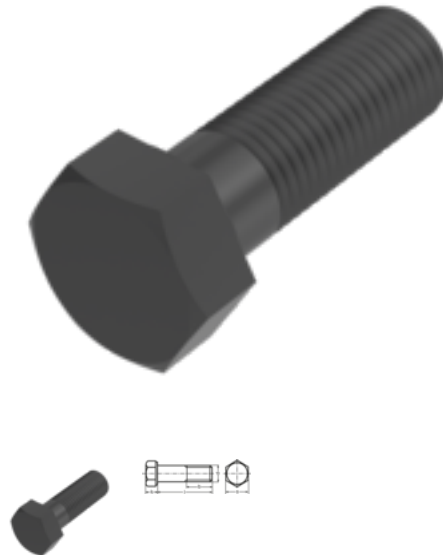

Article number
140931695

EAN
None

Weight in kg
0.022

Customs number
73181588

Diameter
6 mm

Length
95 mm

Material
Steel

Quality additional filter
8.8

Coating
pln

Force application
SW 10

Norm
ISO 4014 / DIN 931

Product details

ISO 4014.

Material	Steel
Total length l	95 mm
Length	95 mm
Norm	ISO 4014
Diameter	6 mm
Height of the head k	4 mm
Coating	pln
Thread length b	18 mm
Force application type	External hex
Norm	ISO 4014 / DIN 931
Quality additional filter	8.8

Force application	SW 10
-------------------	-------

Diameter d	6 mm
------------	------

Remarks

Changed SW for ISO. M 10, M 12, M 14 and M 22 only available according to DIN 931. For further sizes see ISO 4014.

Application

Universell einsetzbar, vor allem im Maschinenbereich

Product variants

Force application	SW 10
Norm	
ISO 4014 / DIN 931	•