

ISO 4017, Hexagon bolt, M 10x90, 8.8, pln

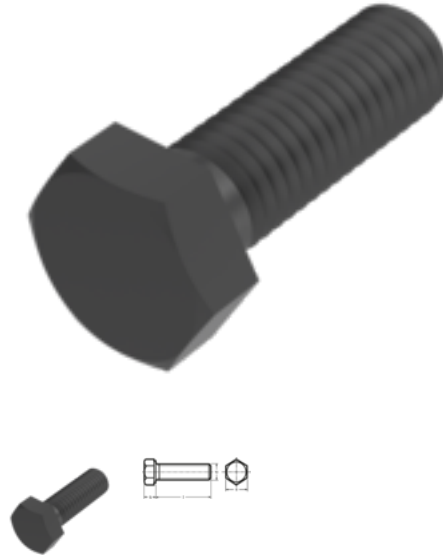

Article number
1440171090

EAN
None

Weight in kg
0.056

Customs number
73181588

Material
Steel

Quality
8.8

Coating
pln

Diameter
10 mm

Length
90 mm

Force application
SW 16

Norm
ISO 4017

Product details

Threaded close up to the head.

Material	Steel
Force application type	External hex
Length	90 mm
Norm	ISO 4017
Total length l	90 mm
Norm	ISO 4017
Diameter	10 mm
Quality	8.8
Force application	SW 16
Height of the head k	6.4 mm
Coating	pln

Diameter d 10 mm

Remarks

Replacement for DIN 933. Changed SW for DIN. Item is delivered according to ISO. For further sizes see DIN 933.

Product variants

Force application	SW 16	SW 17
Norm		
DIN 933		•
ISO 4017	•	