

ISO 4014 / DIN 931, hexagon head bolt, M 16x45, 10.9, pln

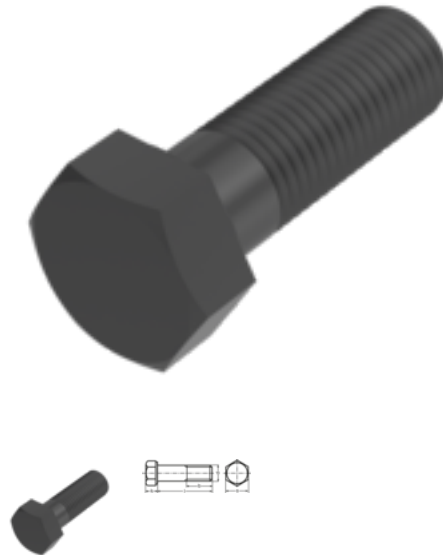

Article number
1509311645

Weight in kg
0.103

Diameter
16 mm

Material
Steel

Coating
pln

Norm
ISO 4014 / DIN 931

EAN
None

Customs number
73181588

Length
45 mm

Quality additional filter
10.9

Force application
SW 24

Product details

ISO 4014.

Material	Steel
Total length l	45 mm
Length	45 mm
Norm	ISO 4014
Diameter	16 mm
Height of the head k	10 mm
Coating	pln
Thread length b	38 mm
Force application type	External hex
Norm	ISO 4014 / DIN 931

Quality additional filter	10.9
Force application	SW 24
Diameter d	16 mm

Remarks

Changed SW for ISO. M 10, M 12, M 14 and M 22 only available according to DIN 931. For further sizes see ISO 4014.

Application

Universell einsetzbar, vor allem im Maschinenbereich

Product variants

Force application	SW 24
Norm	
ISO 4014 / DIN 931	•