

# ISO 4014 / DIN 931, hexagon head bolt, M 20x150, 10.9, pln

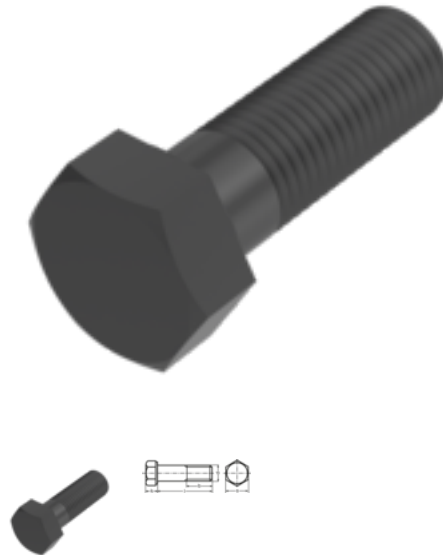

**Article number**  
15093120150

**Weight in kg**  
0.422

**Diameter**  
20 mm

**Material**  
Steel

**Coating**  
pln

**Norm**  
ISO 4014 / DIN 931

**EAN**  
None

**Customs number**  
73181588

**Length**  
150 mm

**Quality additional filter**  
10.9

**Force application**  
SW 30

## Product details

ISO 4014.

Material	Steel
Total length l	150 mm
Length	150 mm
Norm	ISO 4014
Diameter	20 mm
Height of the head k	12.5 mm
Coating	pln
Thread length b	52 mm
Force application type	External hex
Norm	ISO 4014 / DIN 931

Quality additional filter	10.9
Force application	SW 30
Diameter d	20 mm

**Remarks**

Changed SW for ISO. M 10, M 12, M 14 and M 22 only available according to DIN 931. For further sizes see ISO 4014.

**Application**

Universell einsetzbar, vor allem im Maschinenbereich

**Product variants**

Force application	SW 30
Norm	
ISO 4014 / DIN 931	•