

DIN 7504 R, Self-drilling tapping screw raised countersunk head, ST 4,8x25, ST, zinc-plated, standard, 5 µm, Zn5/An/T0, H 2

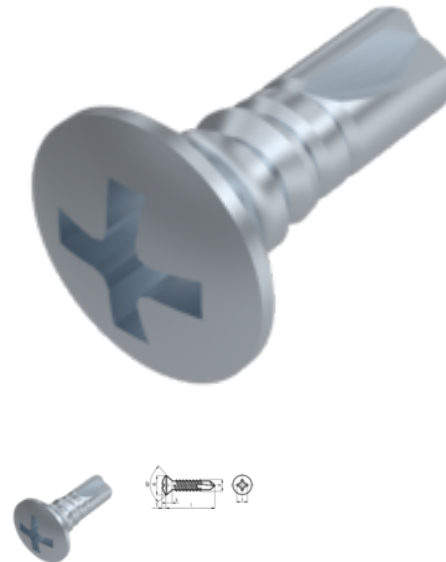

Article number
20750494825

EAN
None

Weight in kg
0.003

Customs number
73181491

Diameter
4,8 mm

Length
25 mm

Product details

R form, raised countersunk head according to DIN 7983.

Force application size	H 2
Material	Steel
Total length l	25 mm
Length	25 mm
Head height f	1.5 mm
Norm	ISO 15483
Diameter	4.8 mm
Height of the head k	3 mm
Diameter of the head dk	9.5 mm
Coating	zinc-plated, standard, 5 µm, Zn5/An/T0
Force application type	Phillips cross recess
Quality	ST

Force application	H 2
Diameter d	4.8 mm

Remarks

Standard was withdrawn. DIN corresponds to ISO 15483 (DRM 3,9 mm not contained in ISO).

Product variants

Diameter (mm)	2,9	3,5	3,9	4,2	4,8
Length (mm)					
13	•	•	•		
16		•		•	•
19	•	•	•	•	•
22		•			•
25			•	•	•
32			•	•	•
38					•
45					•
50					•