

ISO 4014 / DIN 931, hexagon head bolt, M 30x400, 8.8, zinc-plated, standard, 5 µm, Zn5/An/T0

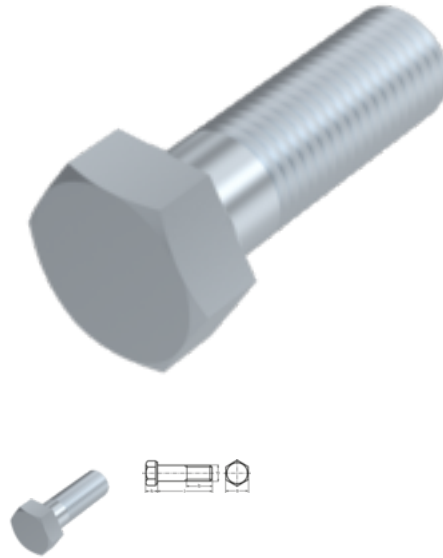

Article number
24093130400

EAN
None

Weight in kg
2.05

Customs number
73181588

Diameter
30 mm

Length
400 mm

Material
Steel

Quality additional filter
8.8

Coating
zinc-plated, standard, 5 µm, Zn5/An/T0

Force application
SW 46

Norm
ISO 4014 / DIN 931

Product details

ISO 4014.

Material	Steel
Total length l	400 mm
Length	400 mm
Norm	ISO 4014
Diameter	30 mm
Height of the head k	18.7 mm
Coating	zinc-plated, standard, 5 µm, Zn5/An/T0
Thread length b	85 mm
Force application type	External hex

Norm	ISO 4014 / DIN 931
Quality additional filter	8.8
Force application	SW 46
Diameter d	30 mm

Remarks

Changed SW for ISO. M 10, M 12, M 14 and M 22 only available according to DIN 931. For further sizes see ISO 4014.

Application

Universell einsetzbar, vor allem im Maschinenbereich

Product variants

Force application	SW 46
Norm	
ISO 4014 / DIN 931	•