

ISO 4014 / DIN 931, hexagon head bolt, M 6x90, 8.8, zinc-plated, standard, 5 µm, Zn5/An/T0

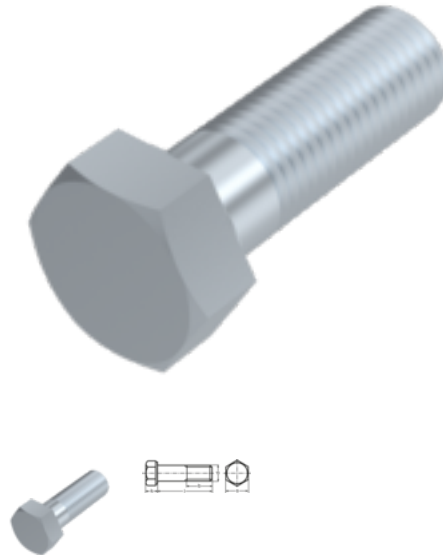

Article number
240931690

EAN
None

Weight in kg
0.021

Customs number
73181588

Diameter
6 mm

Length
90 mm

Material
Steel

Quality additional filter
8.8

Coating
zinc-plated, standard, 5 µm, Zn5/An/T0

Force application
SW 10

Norm
ISO 4014 / DIN 931

Product details

ISO 4014.

Material	Steel
Total length l	90 mm
Length	90 mm
Norm	ISO 4014
Diameter	6 mm
Height of the head k	4 mm
Coating	zinc-plated, standard, 5 µm, Zn5/An/T0
Thread length b	18 mm
Force application type	External hex

Norm	ISO 4014 / DIN 931
Quality additional filter	8.8
Force application	SW 10
Diameter d	6 mm

Remarks

Changed SW for ISO. M 10, M 12, M 14 and M 22 only available according to DIN 931. For further sizes see ISO 4014.

Application

Universell einsetzbar, vor allem im Maschinenbereich

Product variants

Force application	SW 10
Norm	
ISO 4014 / DIN 931	•