

DIN 6924, Hexagon nut, M 5, 8, zinc-plated, standard, 5 μ m, Zn5/An/T0

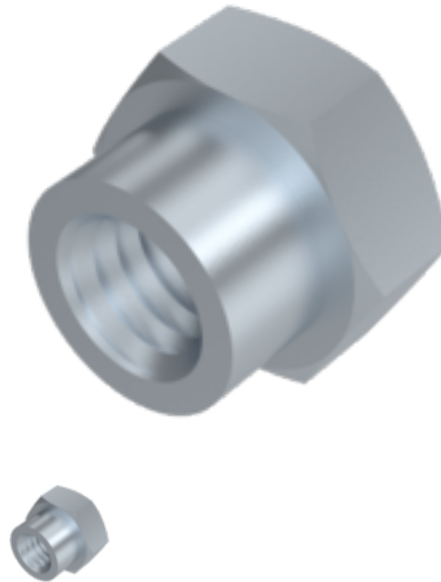

Article number
2469245

EAN
None

Weight in kg
0.001

Customs number
73181660

Quality
8

Coating
zinc-plated, standard, 5 μ m, Zn5/An/T0

Diameter
5 mm

Product details

With non-metallic insert, with locking insert.

Material	Steel
Force application type	External hex
Height h1	4.4 mm
Height h	6.8 mm
Minimum height for recess km	3.5 mm
Norm	DIN 6924
Diameter	5 mm
Quality	8
Force application	SW 8
Coating	zinc-plated, standard, 5 μ m, Zn5/An/T0
Diameter d	5 mm

Remarks

Standard was withdrawn. DIN corresponds to ISO 7040. Changed SW and height for ISO. Item is delivered according to DIN.

Product variants

Coating	zinc-plated, standard, 5 µm, Zn5/An/T0
Diameter (mm)	
3	•
4	•
5	•
6	•
8	•
10	•
12	•
16	•
20	•
24	•
27	•
36	•