

DIN 7984, cap screw, M 6x20, 08.8, zinc-plated, standard, 5 µm, Zn5/An/T0

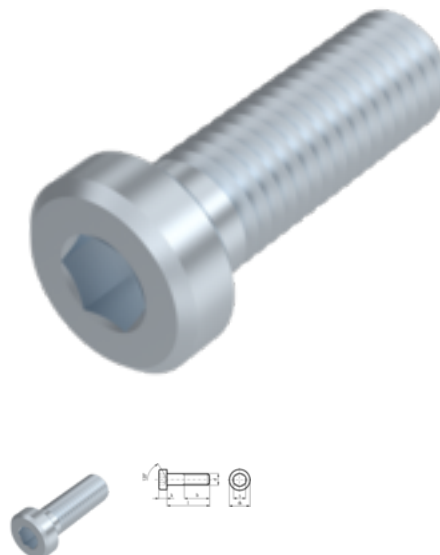

Article number
247984620

EAN
None

Weight in kg
0.005

Customs number
73181568

Material
Steel

Coating
zinc-plated, standard, 5 µm, Zn5/An/T0

Quality additional filter
08.8

Force application type
Hex socket

Diameter
6 mm

Length
20 mm

Product details

Material	Steel
Total length l	20 mm
Length	20 mm
Norm	DIN 7984
Diameter	6 mm
Height of the head k	4 mm
Diameter of the head dk	10 mm
Coating	zinc-plated, standard, 5 µm, Zn5/An/T0
Thread length b	20 mm
Force application type	Hex socket
Quality additional filter	08.8
Quality	08.8

Force application ISK 4

Diameter d 6 mm

Remarks

Load-bearing capacity 80%.

Product variants

Diameter (mm)	3	4	5	6	8	10	12	16	20	24
Length (mm)										
4	•									
5	•	•								
6	•	•	•	•						
8	•	•	•	•	•					
10	•	•	•	•	•					
12	•	•	•	•	•	•				
14		•	•	•	•					
16	•	•	•	•	•	•	•			
18			•	•	•	•				
20	•	•	•	•	•	•	•			
22		•	•	•	•					
25	•	•	•	•	•	•	•			
30		•	•	•	•	•	•	•		
35	•	•	•	•	•	•	•	•		
40		•	•	•	•	•	•	•	•	
45		•	•	•	•	•	•	•		
50		•	•	•	•	•	•	•	•	
55			•	•	•	•	•	•		
60			•	•	•	•	•	•	•	•
65					•	•	•	•		
70				•	•	•	•	•		
75						•				
80					•	•	•	•		
90				•	•					
100									•	
180						•				