

DIN 931, hexagon head bolt, M 10x65, 8.8, HDG, ISO suitable

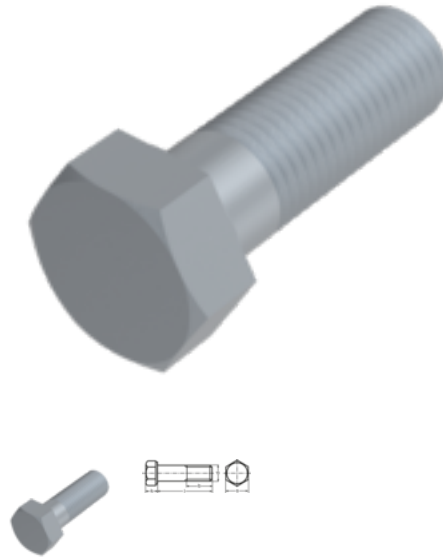

Article number
2509311065

Weight in kg
0.05

Diameter
10 mm

Material
Steel

Coating
HDG, ISO suitable

Norm
DIN 931

EAN
None

Customs number
73181588

Length
65 mm

Quality additional filter
8.8

Force application
SW 17

Product details

ISO 4014.

Material	Steel
Total length l	65 mm
Length	65 mm
Norm	DIN 931
Diameter	10 mm
Height of the head k	6.4 mm
Coating	HDG, ISO suitable
Thread length b	26 mm
Force application type	External hex
Norm	DIN 931

Quality additional filter	8.8
Force application	SW 17
Diameter d	10 mm

Remarks

Changed SW for ISO. M 10, M 12, M 14 and M 22 only available according to DIN 931. For further sizes see ISO 4014.

Application

Universell einsetzbar, vor allem im Maschinenbereich

Product variants

Force application	SW 17
Norm	
DIN 931	•