

DIN 933, hexagon head bolt, M 16x80, A2-70

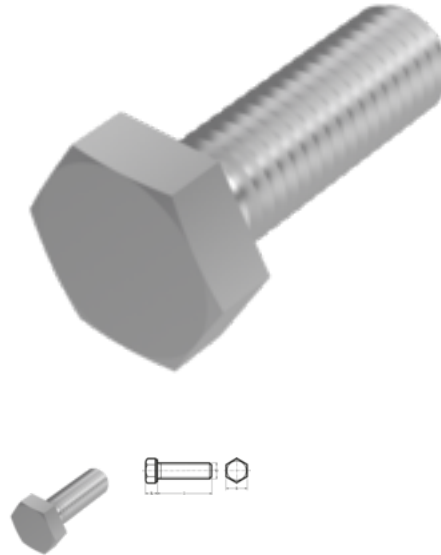

Article number
5209331680

EAN
None

Weight in kg
0.144

Customs number
73181575

Material
Stainless steel

Quality
A2-70

Coating
pln

Diameter
16 mm

Length
80 mm

Force application
SW 24

Norm
ISO 4017 / DIN 933

Product details

Threaded close up to the head.

Material	Stainless steel
Force application type	External hex
Length	80 mm
Norm	ISO 4017 / DIN 933
Total length l	80 mm
Norm	ISO 4017
Diameter	16 mm
Quality	A2-70
Force application	SW 24
Height of the head k	10 mm
Coating	pln

Diameter d 16 mm

Remarks

Standard was withdrawn. DIN similar to ISO 4017. Changed SW for ISO. Sizes M 10, M 12, M 14 and M 22 only available in DIN 933. For further sizes see ISO 4017.

Material:

up to M 20 : A2-70

from M 22 : A2-50.

Application

Universell einsetzbar, vor allem im Maschinenbereich

Product variants

Force application	SW 24
Norm	
ISO 4017 / DIN 933	•