

ISO 13918 PT, Welding threaded stud, M 8x25, A2-50

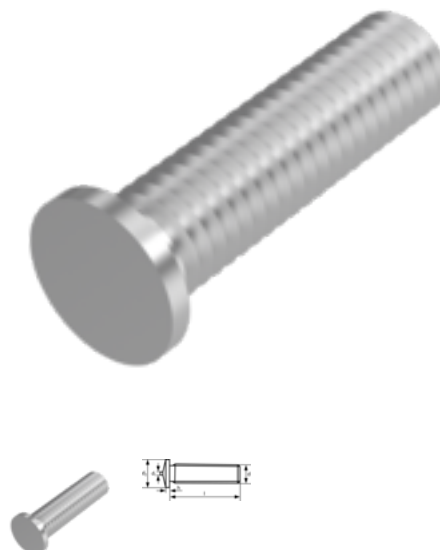

Article number
52139189825

EAN
None

Weight in kg
0.008

Customs number
73181595

Material
Stainless steel

Quality
A2-50

Coating
pln

Diameter
8 mm

Length
25 mm

Product details

Form PT-Stud welding with tip ignition

Lenght l1	0.85 mm
Material	Stainless steel
Total lenght l	25 mm
Length	25 mm
Diameter d1	0.75 mm
Norm	ISO 13918 PT
Diameter	8 mm
Quality	A2-50
Coating	pln
Diameter of the head dk	9 mm
Diameter d	8 mm

Remarks

32501-1 has been replaced by ISO 13918

Product variants

Diameter (mm)	3	4	5	6	8	10
Length (mm)						
6			•			
8	•		•	•		
10	•		•	•	•	
12	•	•	•	•	•	
15			•	•	•	
16		•	•	•	•	
20	•	•	•	•	•	•
25	•	•	•	•	•	•
30		•	•	•	•	
35		•	•	•	•	
40			•	•	•	
45					•	
50		•			•	
55				•		
60					•	