

ISO 4017, Hexagon bolt, M 12x80, A4-80

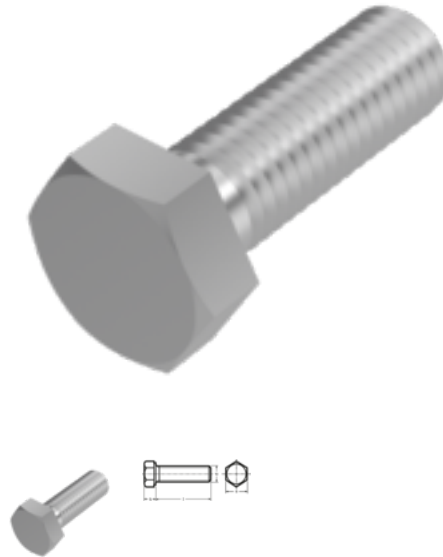

Article number
54840171280

EAN
None

Weight in kg
0.074

Customs number
73181575

Material
Stainless steel

Quality
A4-80

Coating
pln

Diameter
12 mm

Length
80 mm

Force application
SW 18

Norm
ISO 4017

Product details

Threaded close up to the head.

Material	Stainless steel
Force application type	External hex
Length	80 mm
Norm	ISO 4017
Total length l	80 mm
Norm	ISO 4017
Diameter	12 mm
Quality	A4-80
Force application	SW 18
Height of the head k	7.5 mm
Coating	pln

Diameter d 12 mm

Remarks

Replacement for DIN 933. Changed SW for DIN. Item is delivered according to ISO. For further sizes see DIN 933.

Product variants

Force application	SW 18	SW 19
Norm		
DIN 933		•
ISO 4017	•	